

Transfer or duplication of this document as well as the utilization or communication of its content are prohibited unless authorized in writing. All rights reserved for patent, utility model or design registrations. 除专利、实用新型、外观设计、软件著作权、集成电路布图设计专有权、商标、名称、企业名称、商号、域名、网站名称、电子邮箱地址、电话号码等在内的所有权利，均保留给德高电气。未经许可，不得复制或传播。

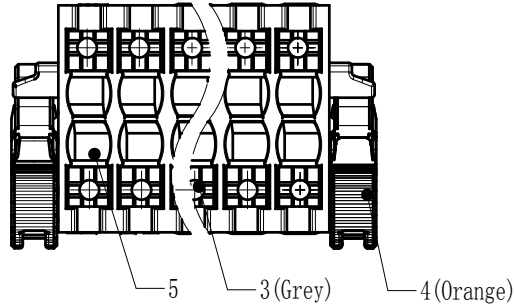

未注公差/General tolerances (mm)												0.1/10		
0	>3	>6	>10	>18	>30	>50	>80	>120	>180	>250	>315		>400	>500
±0.12	±0.18	±0.22	±0.26	±0.31	±0.37	±0.57	±0.80	±0.93	±1.05	±1.15	±1.60	±2.20	±2.50	±2'

UL 标准/UL Standard:	B	C	D
额定电压/电流/Rated Voltage(V)/Current(A)	300/10	50/10	300/10
IEC 标准/IEC Standard:			
过压类别/Overvoltage Category/污染等级/Pollution Degree	III/3	III/2	II/2
额定电压/电流/Rated Voltage(V)/Current(A)	160/10	160/10	320/10
额定脉冲电压(KV)/Rate Impulse Voltage(KV)	2.5	2.5	2.5
线径范围(硬线和软线)/Wire Range(rigid and flexible)(AWG/mm <sup>2</sup> )	28~16 / 0.2~1.5		
间距/Pitch(mm)/线数范围/Poles	3.5/N=04~48P		
剥线长度/Stripping length(mm)	10~11		
使用温度范围/Operating temperature(°C)	-40~+105		
符合RoHS环保要求/Conform to RoHS	Yes		

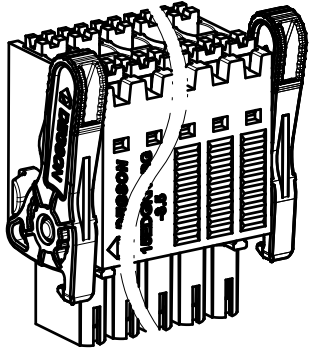
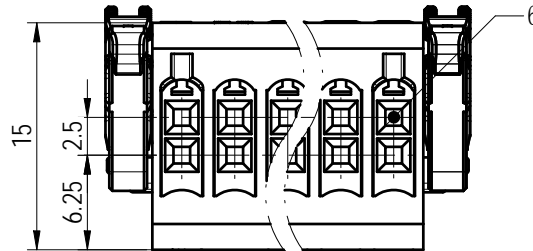
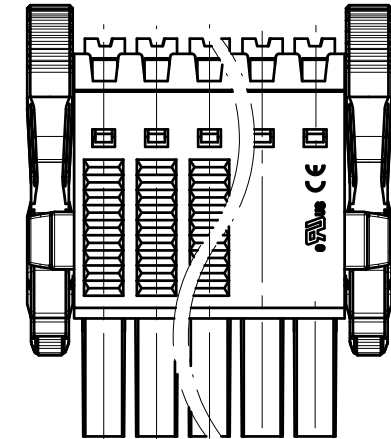
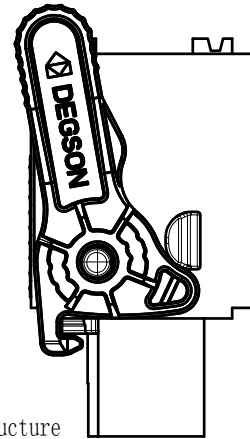
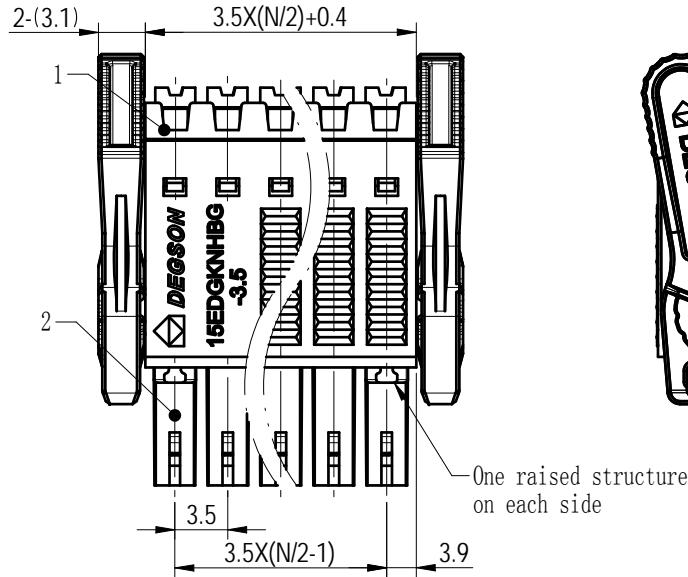
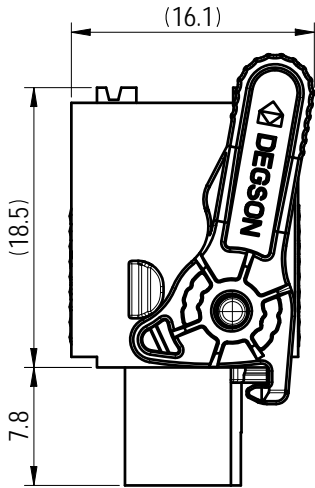

Note: The A&Z(H) in the name means: A(H) and Z(H).

ITEM	NAME OF PART	MATERIAL	NOTES
6	Clamp	Copper Alloy	Sn Plated
5	Spring	Stainless steel	/
4	Handle	PA66-GF	UL94V-0
3	Button	PA66-GF	UL94V-0
2	Housing	PA66-GF	UL94V-0
1	Cover	PA66-GF	UL94V-0

		MATERIAL:	SURFACE/COLOR:		
APPD: 兰春华	2024.03.08	MAT NO./REV:	MAT STATUS: 批量		
CHKD: 张玉华	2024.03.08	NAME			
DRFT: 陈迪辉	2024.03.06	15EDGKNHBG-3.5-XXP-1Y-100A&Z(H)			
DRAWING NO. 200101245		TYPE	DRAWING STATUS	SCALE	SHEET
A4		CUSTOMER DRAWING	已发布	2:1	1/1

REV	ECN	DESCRIPTION	DRFT	DATE
03		wipe off VDE mark	陈迪辉	2024.03.06