

Pole	Width /W	Pitch /P	Width/F	Width/BO	Qty. per reel	Reel qty. per carton	Qty. per carton
02P	24mm	16mm	11.50mm	7.92mm	300	10	3000
03P	24mm	16mm	11.50mm	11.73mm	300	10	3000
04P	32mm	16mm	14.20mm	15.54mm	300	8	2400
05P	44mm	16mm	20.20mm	19.35mm	300	5	1500
06P	44mm	16mm	20.20mm	23.16mm	300	5	1500

未注公差/General tolerances (mm)												0.1/10 ±2'	
0	>3	>6	>10	>18	>30	>50	>80	>120	>180	>250	>315		>400
±0.12	±0.18	±0.22	±0.26	±0.31	±0.37	±0.57	±0.80	±0.93	±1.05	±1.15	±1.60	±2.20	±2.50

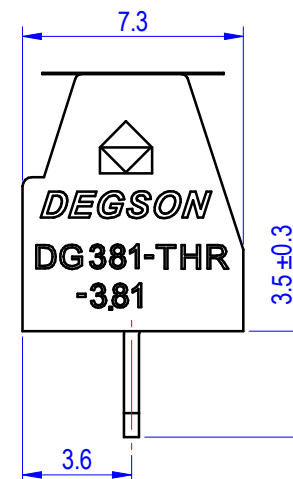
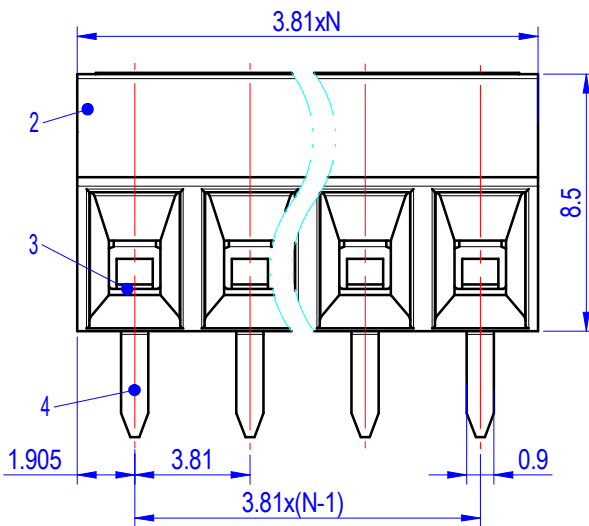
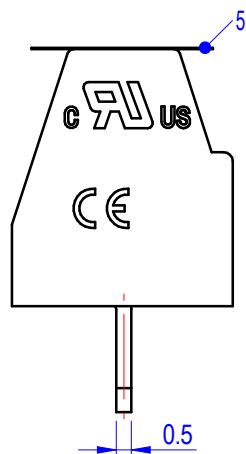
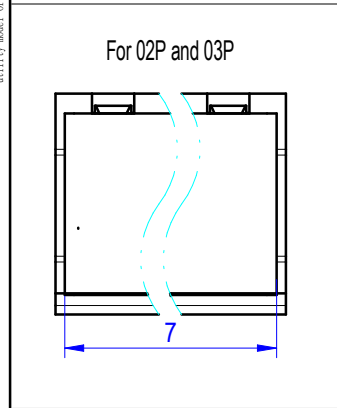
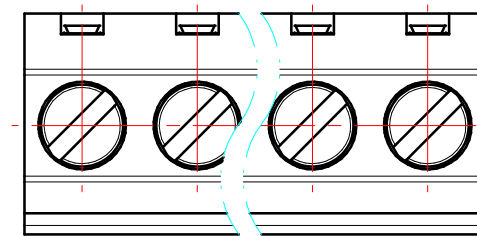
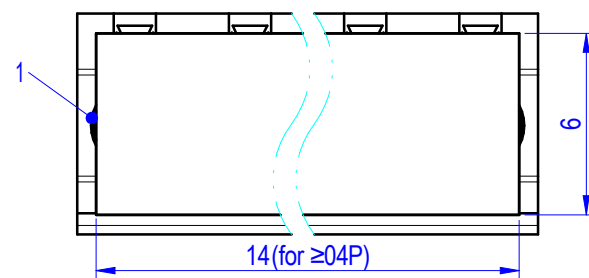
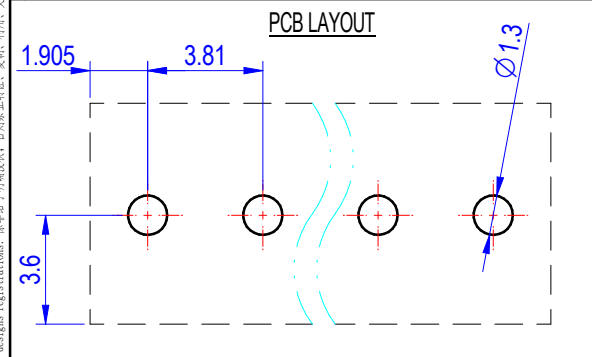
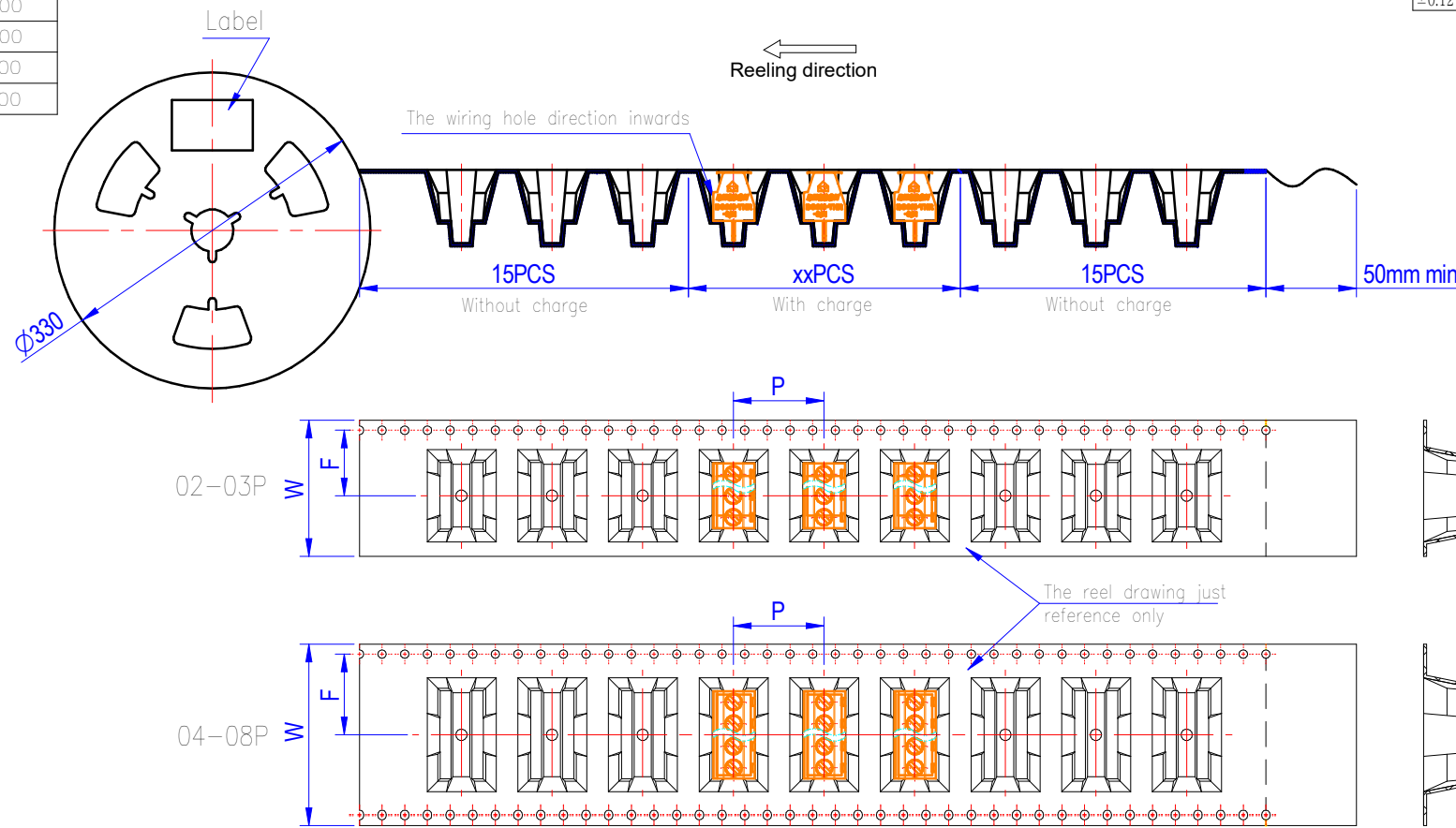

ITEM	NAME OF PART	MATERIAL	NOTES
5	Tape	Kapton	/
4	Pin_header	Copper alloy	Sn plated
3	Cage	Copper alloy	M2/Ni plated
2	Housing	Thermoplastic	UL94V-0
1	Screw	Steel	M2/Zn plated

UL 标准/UL Standard:	B	C	D
额定电压/电流/Rated Voltage(V)/Current(A)	150/10	/	/
IEC 标准/IEC Standard:			
过压类别/Overtage Category/污染等级/Pollution Degree	III/3	III/2	II/2
额定电压/电流/Rated Voltage(V)/Current(A)	63/13.5	200/13.5	200/13.5
额定脉冲电压(KV)/Rate Impulse Voltage(KV)	2.5	2.5	2.5
螺丝扭矩/Torque Tightening(N·m/Lbin)	M2, 0.2/1.77		
线径范围(硬线和软线)/Wire Range(rigid and flexible)(AWG/mm²)	30~16/0.2~1.5		
间距/Pitch(mm)/线数范围/Poles	3.81/N= 02~ 08P		
剥线长度/Stripping length(mm)	5~6		
使用温度范围/Operating temperature(°C)	-40~ +130		
符合RoHS环保要求/Conform to RoHS	Yes		

DEGSON		MATERIAL:	SURFACE/COLOR:	
APPD: 兰春华	2024.08.19	MAT NO./REV:	/ 00 MAT STATUS: 批量	
CHKD: 陈招	2024.08.16	NAME		
DRFT: 唐本恒	2024.08.15	DG381-THR-3.81-XXP-1Y-00A&Z(H)		
REV	ECN	DRAWING NO.	TYPE	DRAWING STATUS
		200123967	CUSTOMER DRAWING	已发布
			SCALE	SHEET
			1:1	1/1

REV	ECN	DESCRIPTION	DRFT	DATE
02		1x 修正俯视图结构	唐本恒	2024.08.15

Transfer or duplication of this document, as well as the utilization or communication of its contents are prohibited unless explicit authorization is granted. Violations will be liable for compensation. All rights reserved for patent. 复制或再行发布此文件, 以及其内容的利用或传播, 均须经本公司明确书面授权。未经授权擅自复制或传播, 本公司保留追究法律责任的权利。 侵权必究。