

### ◆ EtherCAT FieldBus Adapter (DF20-C-EC)

- DF20-C-EC the fieldbus adapter from standing and ETHERCAT are linked together, as a ETHERCAT is open in the area of automation of industrial Ethernet standards. It automatically configures and generates local process images including analog, digital, and special functional modules. Analog module and special function module (word-by-word data transfer), digital module (bit-by-bit data transfer).
- The fieldbus coupler is integrated into the application as a ETHERCAT device.
- The coupler features an integrated 2-port switch, allowing easy line structure creation without additional network components.

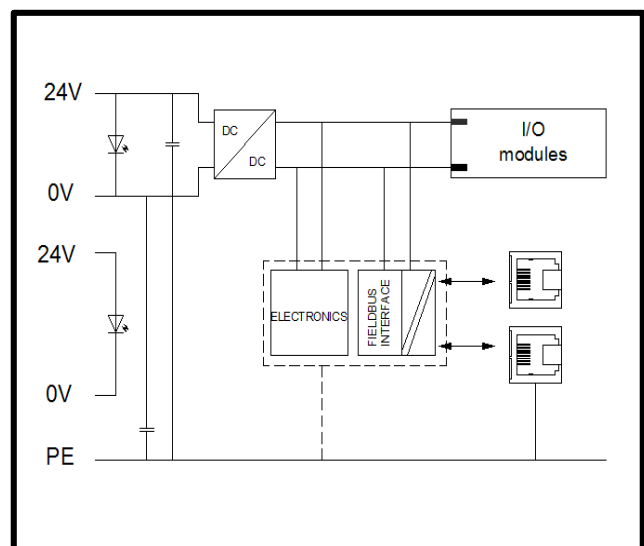
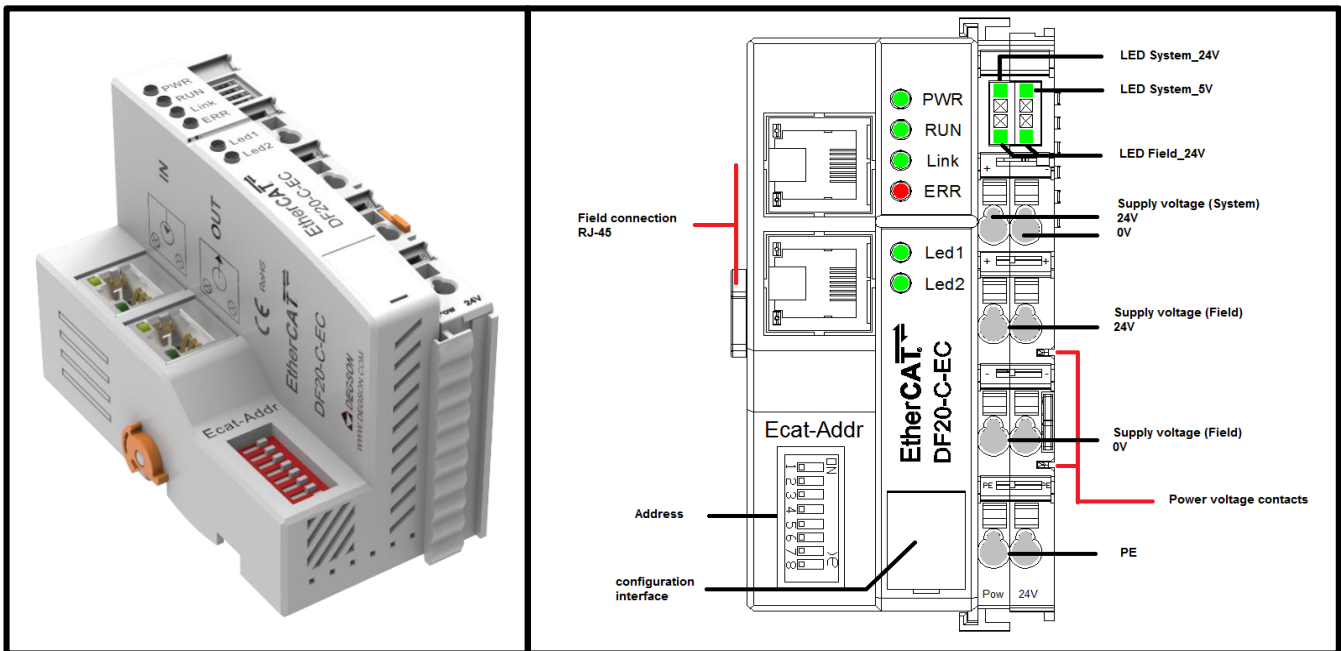

## 1. Specification

| <b>Technical data</b>                                                             |                                                  |
|-----------------------------------------------------------------------------------|--------------------------------------------------|
| Communication                                                                     | EtherCAT                                         |
| Bus segment length (max.)                                                         | 100M                                             |
| Transmission medium                                                               | Twisted Pair S-UTP; 100 Ω; Cat. 5                |
| Transmission rate                                                                 | 10/100Mbps, full duplex                          |
| Number of extensible modules                                                      | 31                                               |
| Address mapping                                                                   | Yes                                              |
| Alias range                                                                       | 1~254                                            |
| PDO DATA                                                                          | 1024 bytes                                       |
| Address setting                                                                   | EtherCAT specification, DIP switch               |
| Connection type                                                                   | via pluggable connector (Spring terminal blocks) |
| Working voltage                                                                   | 24VDC (-15%~+20%)                                |
| Current without load                                                              | <150mA                                           |
| Supply system voltage                                                             | 5VDC                                             |
| Supply system current                                                             | 600mA                                            |
| Supply field voltage                                                              | 24V~32VDC; via power jumper contacts             |
| Supply field current(max.)                                                        | 5A                                               |
| Isolation                                                                         | 500V system/field Electrical isolation           |
| <b>Connection data</b>                                                            |                                                  |
| Connection technology: communication/fieldbus                                     | EtherCAT: 2 x RJ-45                              |
| Connection technology: system supply                                              | 2 x via pluggable connector                      |
| Connection technology: field supply                                               | 6 x via pluggable connector                      |
| Connection type 1                                                                 | System/field supply                              |
| Area of wire                                                                      | 0.2~2.5mm <sup>2</sup> /28~14AWG                 |
| Strip length                                                                      | 8~9mm/0.31~0.35inches                            |
| Mounting type                                                                     | DIN-35 RAIL                                      |
| <b>Material Data</b>                                                              |                                                  |
| Color                                                                             | light gray                                       |
| Housing material                                                                  | Polycarbonate; polyamide 6.6                     |
| Conformity marking                                                                | CE                                               |
| <b>Environmental requirements</b>                                                 |                                                  |
| Ambient temperature (operation)                                                   | -25~60°C                                         |
| Surrounding air temperature (storage)                                             | -40~85°C                                         |
| Protection type                                                                   | IP20                                             |
| Pollution degree (5)                                                              | 2, Per IEC 61131-2                               |
| Operating altitude                                                                | without temperature derating: 0~2000m            |
| Mounting position                                                                 | Any                                              |
| Relative humidity (without condensation)                                          | 5~95%RH                                          |
| Vibration resistance                                                              | 4g, Per IEC 60068-2-6                            |
| Shock resistance                                                                  | 15g, Per IEC 60068-2-27                          |
| EMC immunity to interference                                                      | Per EN 61000-6-2                                 |
| EMC emission of interference                                                      | Per EN 61000-6-3                                 |
| Exposure to pollutants                                                            | Per IEC 60068-2-42 and IEC 60068-2-43            |
| Permissible pollutant concentration H <sub>2</sub> S at a relative humidity < 75% | 10ppm                                            |
| Permissible pollutant concentration SO <sub>2</sub> at a relative humidity < 75%  | 25ppm                                            |

## 2. Hardware Interface

- Wiring Terminal

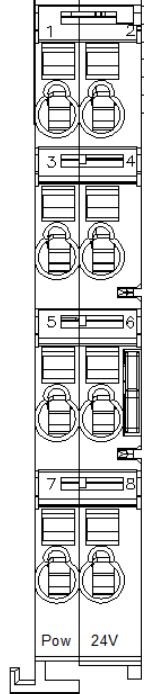

| NO. | Definition       | Description                           |
|-----|------------------|---------------------------------------|
| 1   | System power 24V | Power the module. Give Goldfinger 5V. |
| 2   | System power 0V  |                                       |
| 3   | Field power 24V  | Power the load.                       |
| 4   |                  |                                       |
| 5   | Field power 0V   |                                       |
| 6   |                  |                                       |
| 7   | PE               | Protect Earthing                      |
| 8   |                  |                                       |

**Notes:** It is recommended to use two isolated 24V power supplies to provide two power supplies for the coupler respectively to achieve the best anti-interference performance.

## ● LED Indicator

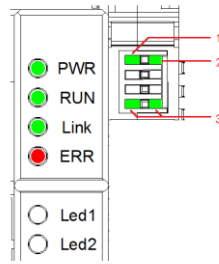

| Indicator | Status       | Description                                                   |
|-----------|--------------|---------------------------------------------------------------|
| PWR       | Green: ON    | Power Normal                                                  |
|           | Green: OFF   | Power Failure                                                 |
| RUN       | Green: ON    | I/O system is running                                         |
|           | Green: OFF   | I/O system is stopping                                        |
| Link      | Green: Flash | Module to establish communication, there is data transmission |
|           | Green: OFF   | Module communication is not established                       |
| ERR       | Red: ON      | data exchanging failure                                       |
|           | Red: OFF     | data exchanging normal                                        |
| Led1      | /            | /                                                             |
| Led2      | /            | /                                                             |
| 1         | Green: ON    | System Power Normal                                           |
|           | Green: OFF   | System Power Failure                                          |
| 2         | Green: ON    | Goldfinger Power Normal                                       |
|           | Green: OFF   | Goldfinger Power Failure                                      |
| 3         | Green: ON    | Field Power Normal                                            |
|           | Green: OFF   | Field Power Failure                                           |

## ● RJ45 Interface

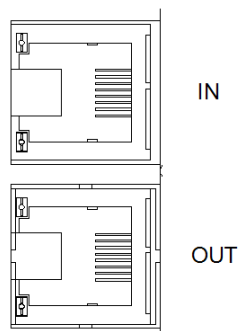

Used to establish communication with the upper computer. The coupler features an integrated 2-port switch, allowing easy line structure creation without additional network components.

- **DIP switch**

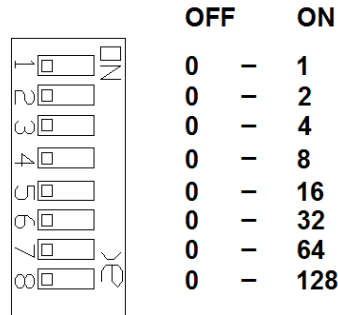

The DIP switch is used to set the adapter module address. It is set by an 8-bit hardware DIP switch. Each EtherCAT adapter has a unique station address (1 to 254).

- **Wiring**

Notes : Only the right side of the adapter is captured here because of the aesthetics.

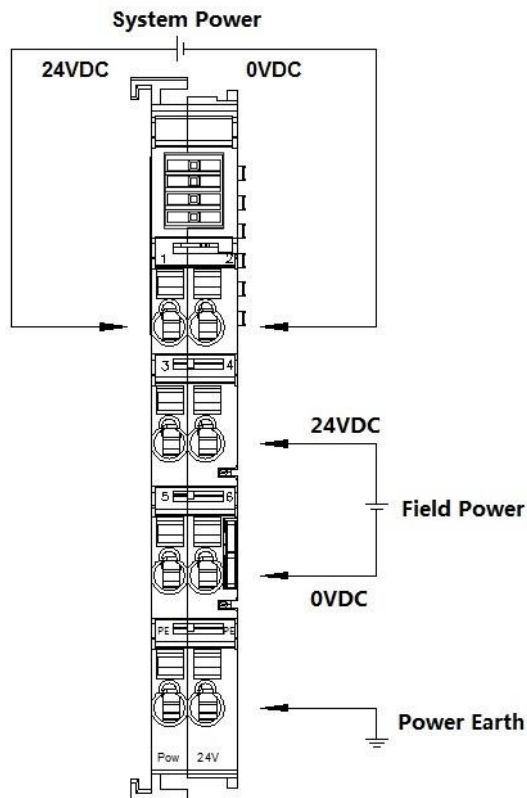

- Configuration Interface

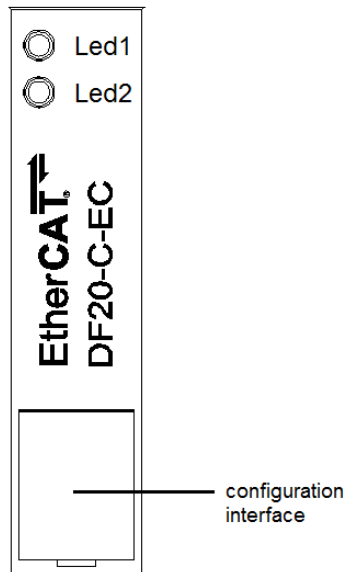

Set the configuration interface to facilitate the adapter program upgrade.

**Notes:** Non-professionals and authorized personnel are prohibited from using this interface to avoid procedural problems.

### 3.Machinery installation

- Dimension drawing

The installation size is shown in the following figure (unit: mm):

